

**INSTALLATION &
OWNER'S MANUAL**

MO-DAD 1, INC.

**MO-DAD MODELS I & II
CLASS 1 SYSTEMS
500/600/750/1000/1500 GALLON CAPACITY**

**COMMERCIAL & RESIDENTIAL
WASTEWATER TREATMENT SYSTEMS**

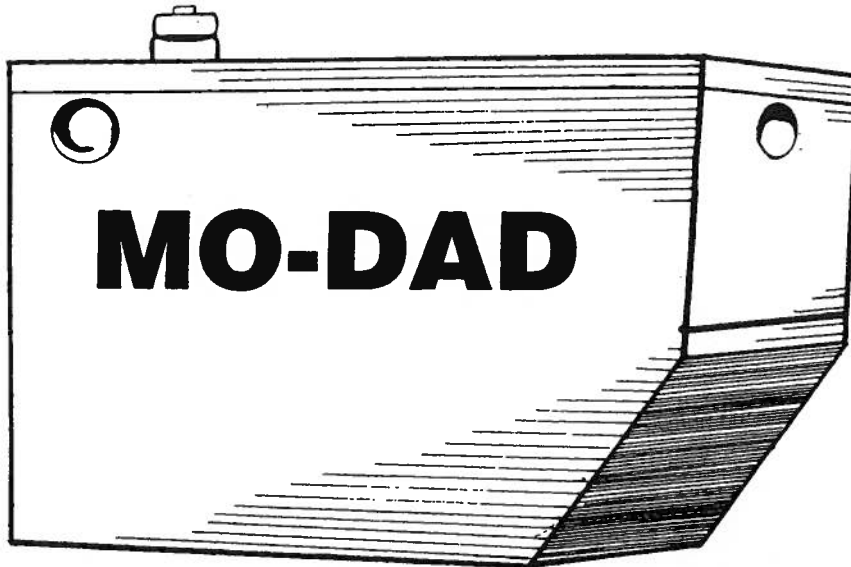

Your Mo-Dad Dealer:

MO-DAD

*America's Choice For Home
Sewage Treatment Systems*

Mo-Dad 1, Inc.

Post Office Box 96

Denham Springs, LA USA 70727-0096

(225) 665-2949

Toll Free (800) 999-0615

BIOLOGICAL PROCESS DESCRIPTION

The MO-DAD 1, INC. Wastewater Treatment System is an economical alternative for use in treating domestic wastewater generated by normal household activities. The process is based on a single-tank, dual-chamber, extended aeration activated sludge system which is capable of producing an effluent which meets applicable state discharge standards. This system has been successfully tested in accordance with National Sanitation Foundation (NSF) Standard 40-2000.

Raw wastewater flows first into an aeration zone and, depending upon the model, the treated water flows into the clarifier (Model I) or is channeled into a secondary aeration zone (Model II) where the aerobic process is repeated before going to the clarifier. The oxygen supplied by the aeration system, along with the organic matter in the wastewater create an ideal environment for the growth of aerobic micro-organisms. The organisms convert the waste organic materials into gases and additional micro-organism cell material. In addition to supplying oxygen, the aeration system keeps the contents of the aeration zone well mixed to provide optimum exposure of the micro-organisms to the waste materials. The action of the beneficial micro-organisms also results in a significant reduction in pathogenic bacteria.

After approximately 24 hours of detainment in the aeration zone, the mixture enters the clarifier where quiescent conditions enable separation of the micro-organisms, which are returned to the aeration zone, and discharge of treated wastewater through the tee pipe assembly. Effluent may be discharged to a ditch or to a new or existing drain field, whichever is required by your local health official.

MO-DAD 1, INC. wastewater treatment systems meet or exceed all effluent water quality requirements as set forth by USEPA and NSF Standard 40-2000. The MO-DAD I & II were tested according to NSF Standards.

General Specifications for Models I & II 500S

Designation: MO-DAD 1, INC., Wastewater Treatment System

Electrical Requirements: Models I & II - 25 watts, 115V/60HZ/ single-phase

Mo-Dad Model I

	Item	Drawing Reference
System Parts	Single Tank (with access cover)	A
	1" PVC Diffuser Assembly	B
	6" PVC Access Port	C
	Grommets (3)	Not Shown
	4" PVC Tee Pipe Outlet Assembly	E
	Air Pump and Warning Device	Not Shown

Notes

PVC influent and effluent lines furnished by owner/installer
 Models available 500, 600, 750, 1000, 1500
 Includes three 90 degree fittings and one warning device
 A data plate with model number, treatment capacity, serial number and manufacturer's address and phone number is installed inside the access port cap and on the air pump

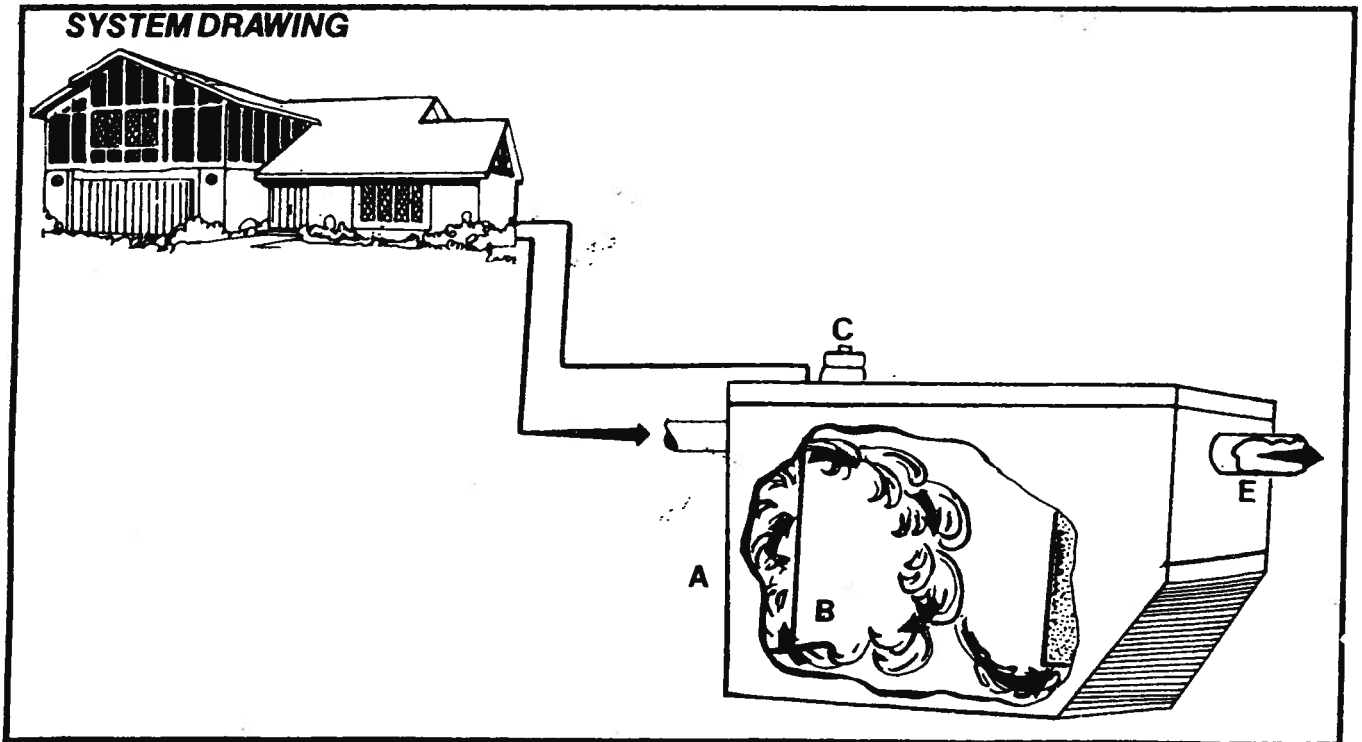

Mo-Dad Model I Installation Instructions

Prior to installation, all state and local laws and regulations must be complied with. For long term reliable and efficient operation, it is essential that the system be installed in accordance with these instructions. Refer to the system drawing for component arrangement.

- Step 1** Prepare excavation for the single tank. Depth for the tank is controlled by the depth of the building sewer. Bottom of excavation must be smooth and level (a 4" layer of sand may be used if desired).
- Step 2** Install rubber grommets in tank inlet, outlet, and access cover (3 total). Grommets should be installed with the fat flange on the exterior of the tank as shown on the drawing. A small amount of grease applied to the inside of the grommets will aid insertion of PVC pipes.
- Step 3** Carefully place the unit into the ground (excavated area). The influent end of the unit will be connected to the building sewer and the effluent end of the unit will be connected to the discharge sewer.
- Step 4** Place air diffuser into tank so that it rests on bottom of the tank with diffuser sitting parallel with the baffle, 6 inches from the influent hole.
- Step 5** Cut a section of 6" PVC pipe (furnished by owner) to suitable length for access port. Slide 2 inches through grommet in access cover. Slide access cover into place with ½ inch PVC air line (furnished by owner) through opening provided.
- Step 6** Install air pump in a clean, well ventilated area such as a tool room, garage, under trailer, on a concrete block, etc., within 60 feet of the tank.
- Step 7** Install ½" PVC air line (furnished by owner) from air pump to diffuser assembly. Pipe should run in a trench at a recommended depth of 12 inches of cover. If vehicular traffic or other usual loading is anticipated, air line should be installed in a casing pipe (PVC, scrap iron, or steel pipe, etc.) for protection.
- Step 8** Backfill excavation up to top of tank being careful not to damage surface coating or dislodge piping. Special care is required around the effluent piping to ensure that the Tee Pipe Outlet Assembly remains in proper position, straight and level.
- Step 9** Fill tank to point of overflowing with water. Operate air pump and check air piping joints for leakage using soapy water solution. Repair if necessary and then carefully backfill trench and remainder of tank excavation(s). Be sure access cover is properly in place.

Mo-Dad Model II Individual Home Wastewater Treatment System

The Mo-Dad II System is a unique concept and design of a three-compartment sewer system. This system was tested at C-K Associates, which is an ANSI/NSF certified lab. At this lab, the Mo-Dad II system went through strenuous testing and has met the ANSI/NSF requirement of the 2000 standards and is approved throughout the United States.

The Mo-Dad II Model Sizes 500, 600, 750, 1000, 1500

Each model of the Mo-Dad II System has three compartments. They are 1) pretreatment aeration compartment, 2) secondary aeration compartment, and 3) a final clarification compartment.

Pretreatment Aeration Compartment

The pretreatment aeration compartment is the first stage of the treatment system. Wastewater from the household enters this compartment where air is introduced to begin the promotion of growth of aerobic organisms. Also, the pre-tank is designed to hold back inorganic material from the aeration compartment.

Secondary Aeration Compartment

In this aeration compartment, wastewater enters through a four-inch collar. This compartment in the Mo-Dad II System is designed to set the right environment for aerobic bacteria to grow by having an air pump which sends in oxygen through low pressure diffusers. These diffusers allow air to flow through them, which blows in all directions mixing up all the solids. This then promotes the growth of aerobic organisms which breakdown the organic solids in the wastewater producing an inorganic and stable organic solid.

Final Clarifier Compartment

Wastewater from the secondary aeration compartment seeps into the clarifier from the bottom of the tank. In the Mo-Dad II System, the clarifier is referred to as the quiet zone. This compartment is called the quiet zone because there is no mixing of solids and wastewater. In the Mo-Dad II System, there is a patent design deflector which diverts the solids back into the aeration compartment to be reprocessed. Another patent component is the Mo-Dad II Divider Tee. This divider diverts the water flow of clean liquids into the effluent discharge by slowing down the flow of water.

Plant Installation Instructions

Prior to installation, all state and local laws must be complied with. It is the owner's responsibility to obtain any required permits.

1. Use equipment parts list to insure that all required parts are on site.
2. Select location of plant site, which is accessible to the home sewer discharge line, in an area that will not receive vehicular traffic. Prepare an excavation site with a hole approximately one (1) foot larger than the treatment plant and depth that will allow for sufficient coverage. The building sewer outlet will control the depth of the plant. The unit must be level for proper operation. Make sure you have a smooth, level surface for a base on which to set the unit. Make sure the electrical blower motor is installed no more than sixty (60) feet away from the tank in a well ventilated area.
3. Carefully place the unit into the ground (excavated area). The influent end of the unit will be connected to the building sewer and the effluent end of the unit will be connected to discharge sewer.

4. Insert building sewer line until it extends approximately two (2) inches inside the unit through the inlet opening (opening at highest elevation). Next, insert four (4) inch PVC discharge pipe in the effluent end opening (opening at lowest elevation).
5. Seal or grout building sewer inlet to the plant with a waterproof, watertight sealant or rubber gasket.
6. Install air blower in a dry location no more than sixty (60) feet from the system.
7. Install a one (1) inch PVC air line from the air blower to the one (1) PVC air downfeed stub-up. The air blower discharge piping should be buried approximately twelve (12) inches after the line has been inspected for air leaks. (refer to step number 11)
8. The electrical controls may be installed in any above ground area where the warning light is visible to the owner during the course of a normal day's activities. All wiring must comply with applicable standards.
9. Carefully backfill around the plant. Use extra precaution not to damage the plant and/or any of the piping.
10. Fill the plant with water to the level of discharge.
11. Turn on air blower and check air piping and fittings for leaks. This can be accomplished by preparing a saturated solution of soap and water and applying to the entire run of pipe and fittings. Make visual observation of bubbles. If no bubbles are observed, the piping and fittings are tight. If a leak is detected, effectively repair and re-test.
12. Backfill the air blower discharge line ditch, influent, and effluent line ditches and the rest of the plant excavation.

Treatment Plant Start-up

Initially the Mo-Dad II System is filled with clean water, usually from the homeowner's water supply. As stated in the installation instructions, once all the proper connections have been completed and it is filled with water and the blower is turned on, the system is in operation.

For the treatment plant to be biologically stable, it will take from four to sixteen weeks after first using the unit to develop a population growth of microorganisms (bacteria). It is bacterium which make the system operate.

Maintenance Schedule

The Mo-Dad II System can be operated and maintained with a minimum amount of problems, if the following procedures are performed on a routine basis.

1. Check high water alarm or audible alarm. If there is a malfunction, you will hear the alarm sound and see a red light on. If on, call for service as indicated on service plate directly above the light.
2. Check around system for build up of ant nests around air pump. Recommended frequency of solid removal is depending on usage.

Mo-Dad Models I & II General Information

Specifications:

Designation	Mo-Dad I or II 500 gpd, single family residential wastewater treatment system
Treatment/Capacity Class	500 gallons per day (gpd)
BOD Loading	500 gpd 1 – 1.5 lbs./day
Electrical Requirements	110/115 volts – 50/60 HZ – Single Phase
Air Blower	Linear Blower

Components:

Tank	Manufactured out of 3000 p.s.i. concrete or alternate material may be 14 - gauge carbon steel asphalt coated and polyethylene.
Riser	Six (6) inch cap
Air Pump	Linear Blower
Electrical Alarm and Sensor	High water / audible and visible alarm system

Mo-Dad Models I & II Owner's Responsibility

It is the owner's responsibility to operate the Mo-Dad System to the best of their ability. To ensure proper operation and minimize problems, please review and follow these guidelines.

1. Do not add strong detergents, disinfectants, or bleaches (other than very small amounts used in daily household cleaning and laundries) to the system.
2. Do not allow the discharge from any type of water softeners or similar equipment into the system.
3. Do not allow any disposable items such as: diapers, tampons, sanitary napkins, large quantities of paper products, tobacco products, or similar items in the system.
4. Do not allow coffee grounds, chemical waste, oils, or grease (such as cooking grease) into the system.
5. Do not allow ant nests to build up around air pump. This can damage electrical components in air pump and alarm panel.
6. To prevent extra maintenance problems please maintain grass and shrubs around system.

Manufacturer Recommended System Additives

The following additives are **not** required but will allow your Mo-Dad System to operate at peak treatment efficiency.

1. ClearStrike™ - can be added to your Mo-Dad System once every six months. It will serve as a shock treatment and help break up greasy build-ups
2. BluGuard™ - can be added monthly to your Mo-Dad System. It will fortify and stimulate biological growth and help deodorize septic smells

Source for obtaining approved replacement parts or approved system additive:

Mo-Dad 1, Inc.
P.O. Box 96
Denham Springs, LA USA 70727-0096
(225) 665-2949
Toll Free (800) 999-0615

Instructions for Intermittent Use

If system is used less than four days a week, a manufacturer approved activation additive, such as BluGuard™ Solution, must be used to ensure proper waste treatment. Please contact manufacturer for product availability and pricing.

Equipment Data Plate

The air pump and high water audible and visible alarm system shall have the following data plate permanently affixed on them:

**High Water and Mechanical Failure
Alarm Label**

MO-DAD 1, INC.
Sewage Treatment Systems
P.O. Box 96
Denham Springs, LA 70727-0096
Model # MO-DAD II
Capacity: 500 GPD Classification: Class I
Alarm-Aerobic
Sewage Tank Malfunction

(800) 999-0615

Blower Label

MO-DAD 1, INC.
Remove Top & Filter
Wash every 6 months or as needed
Model #: MO-DAD I & MO-DAD II
P.O. Box 96
DENHAM SPRINGS, LA 70727-0096
CAPACITY 500 GPD
VOLT 115, 60 HZ WATT 25, 5W CLASS I
FOR SERVICE CALL (800) 999-0615

U.S. Patent
SERIAL No.

OPERATING INSTRUCTIONS

Once installed, the blower will run twenty-four (24) hours a day, so the systems will operate with a minimal amount of attention. It will take 4 to 16 weeks after startup to develop an optimum amount of micro-organisms. To ensure proper operation and minimize maintenance requirements, the following material should not be permitted to enter the system:

Strong disinfectants or bleaches (other than small amounts normally used in laundry - *be conservative*)

Oils, greases, and chemical wastes

Disposable diapers, tampons, sanitary napkins, cigarette butts and similar items

Discharge from water softener

ROUTINE SYSTEM CHECKS TO BE PERFORMED BY SYSTEM OWNER

The following actions should be accomplished to ensure trouble-free operation:

Check air pump to be sure it is operating. Once accustomed to the soft humming sound of a properly operating unit, any unusual noise is an indication of a malfunction. If noise is detected or if alarm signals, check power source, then call dealer for service.

Check water discharge monthly. If discharge is black or murky, call dealer for service.

Check inlet filter on air pump every six months and change or wash, if necessary. Filter should be cleaned or changed more often if conditions warrant.

LIMITED WARRANTY

MO-DAD 1, INC., (hereinafter referred to as Manufacturer) warrants each wastewater treatment system up to 1000S to be free of defects in materials and workmanship for a period of three (3) years and each 1000S and 1500S for a period of 1 (one) year from the date of purchase. When properly registered with the manufacturer, Manufacturer's sole obligation under this warranty shall be to repair or exchange any component part, F.O.B. factory, that in manufacturer's judgment shows evidence of defects, provided said component part has been paid for and is returned through an authorized dealer, transportation prepaid. The warranty must specify the nature of the defect to the Manufacturer.

This warranty does not cover systems that have been flooded by an external means, disassembled by unauthorized persons, improperly installed, subjected to external damage, damage due to improper electrical wiring, or systems treating other than normal household wastewater.

This warranty applies only to the treatment system, and does not include any of the house wiring, plumbing, drainage, or disposal system. Manufacturer is not responsible for any delay or damages caused by defective components or material, or for loss incurred because of interruption of service, or for any other special or consequential damages or incidental expenses arising from the manufacture, sale, or use of this system.

Manufacturer reserves the right to revise, change or modify the construction and design of the treatment system or any component system or any component part or parts thereof without incurring any obligation to make such changes or modifications to previously sold equipment. Manufacturer also reserves the right, in making replacements of component parts under this warranty, to furnish a component part which, in its judgment, is equivalent to the part replaced.

Under no circumstances will manufacturer be responsible to warrantee for any other direct or consequential damages, including but not limited to lost profits, lost income, labor charges, delays in production, which damages are caused by a defect in materials and/or workmanship in its parts.

This warranty is expressly in lieu of any other expressed or implied warranty, excluding any warranty of merchantability or fitness, and of any other obligation on the part of Manufacturer.

Warranty applies only to the treatment system itself and does not include any of the purchaser's plumbing, drainage, and or disposal systems or household wiring and/or any plumbing or device added after the outlet.

MO-DAD I & II KIT PARTS

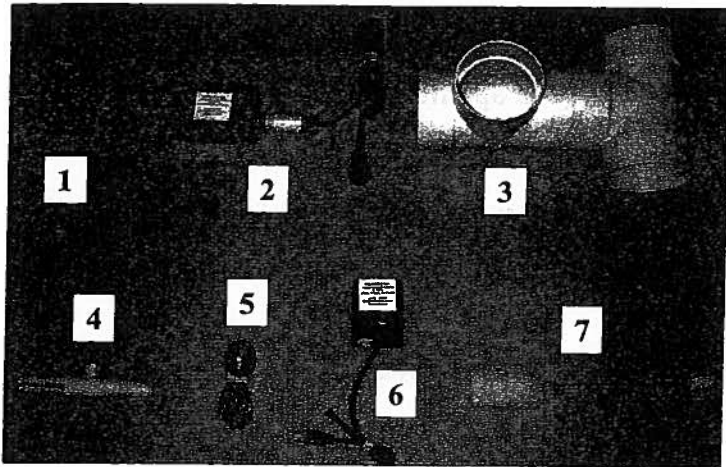

1. Visual and audio alarm that indicates any mechanical failure or weakening of blower. This also sounds if there is high water.
2. This is also a visual and audio alarm that does the same as #2. The difference is that the alarm may be plugged in and moved to a better position in order for it to be seen with or without the power cord.
3. Double Tee prevents solids from exiting the system.
4. The valve that is placed in the air line to connect to the visual and audio alarm.
5. The plastic tubing that connects to the valves in the air line and visual and audio alarm.
6. This is also a visual and audio alarm that does the same as #2 (optional).
7. The float that is placed in the tank connected to the diffuser air line.

TOP VIEW

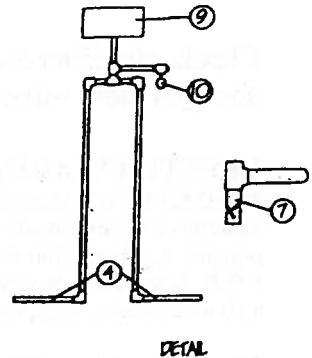
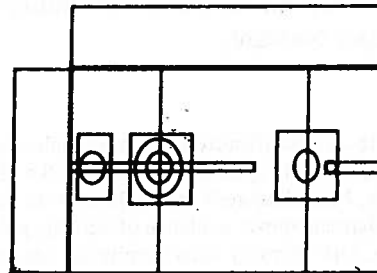

MO-DAD II COMPONENTS

1. Pre-Treatment Aeration Compartment
2. Secondary Aeration Compartment
3. Clarifier Chamber
4. Aeration Diffusers
5. 4" Opening
6. Sludge Deflector
7. Flow Diversion Tee
8. Riser 6" Cap (Optional)
9. Air Pump
10. High Level Alarm Float
11. Control Panel (Optional)

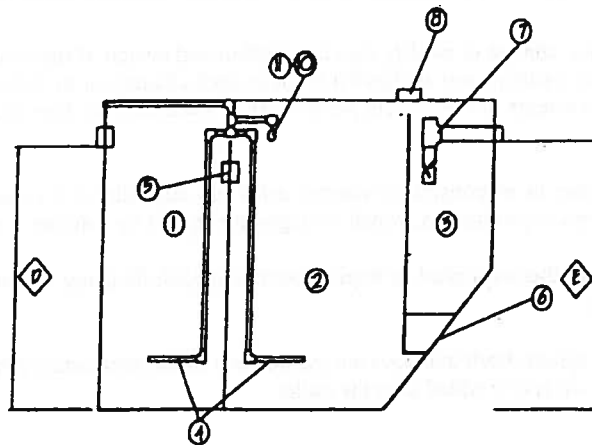

SECTIONAL VIEW

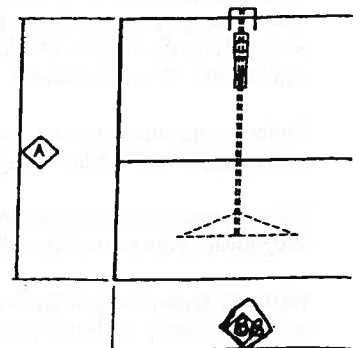

SIDE VIEW

SERVICE POLICY ON MO-DAD MODELS I & II

- Service Calls** The purchase price for the system includes an initial two year service policy, which includes all service calls as needed due to equipment failures or manufacturer's defect. These service calls will be made by the dealer or his authorized representative and shall cover:
- Adjustment** Servicing of air pump, including replacement or cleaning of inlet filter if necessary.
- Notification** Immediate notification of owner in writing of any improper operation observed which cannot be immediately remedied. Manufacturer shall advise owner of problem and if covered by warranty, the estimated date for correction of the problem.
- Inspection** The unit is to be inspected every six (6) months during the initial 2 year service policy period. Servicing should include a check of the filter in the air compressor for proper air flow, and inspection of all electrical connections. Check for effluent quality including a visual check for color, turbidity, and scum overflow.

REPLACEMENT POLICY

- Original Warranty** There shall be no charge to the owner for the repair or replacement of components covered by the warranty.
- Continuing Warranty** A continuing service policy is available from the dealer to system owners whose initial service policy has expired.

WARRANTY REGISTRATION CERTIFICATION

- Complete Certificate within 30 Days** Complete certificate, detach and mail to the following address within thirty (30) days of purchase:

MO-DAD 1, INC.
POST OFFICE BOX 96
DENHAM SPRINGS, LA 70727-0096

Serial Number: _____	Model Number: _____
Date of Installation: _____	
Purchaser's Name: _____	
Address (NO P.O. BOX): _____	
City: _____	State: _____ Zip: _____
Dealer's Name: _____	
Address: _____	
City: _____	State: _____ Zip: _____

HOMEOWNER'S COPY – Please retain for your records.

Serial Number: _____	Model Number: _____
Date of Installation: _____	
Purchaser's Name: _____	
Address (NO P.O. BOX): _____	
City: _____	State: _____ Zip: _____
Dealer's Name: _____ Phone: _____	
Address: _____	
City: _____	State: _____ Zip: _____

MO-DAD

*America's Choice For Home
Sewage Treatment Systems*

MO-DAD 1, INC.
Post Office Box 96
Denham Springs, Louisiana USA 70727-0096
(225) 665-2949
Toll Free (800) 999-0615

PLACE
STAMP
HERE

MO-DAD 1, INC.
Post Office Box 96
Denham Springs, LA 70727-0096